

# Panasonic<sup>®</sup>

## Operating Instructions

### LCD Video Monitor

Model BT- **LH1700W** P

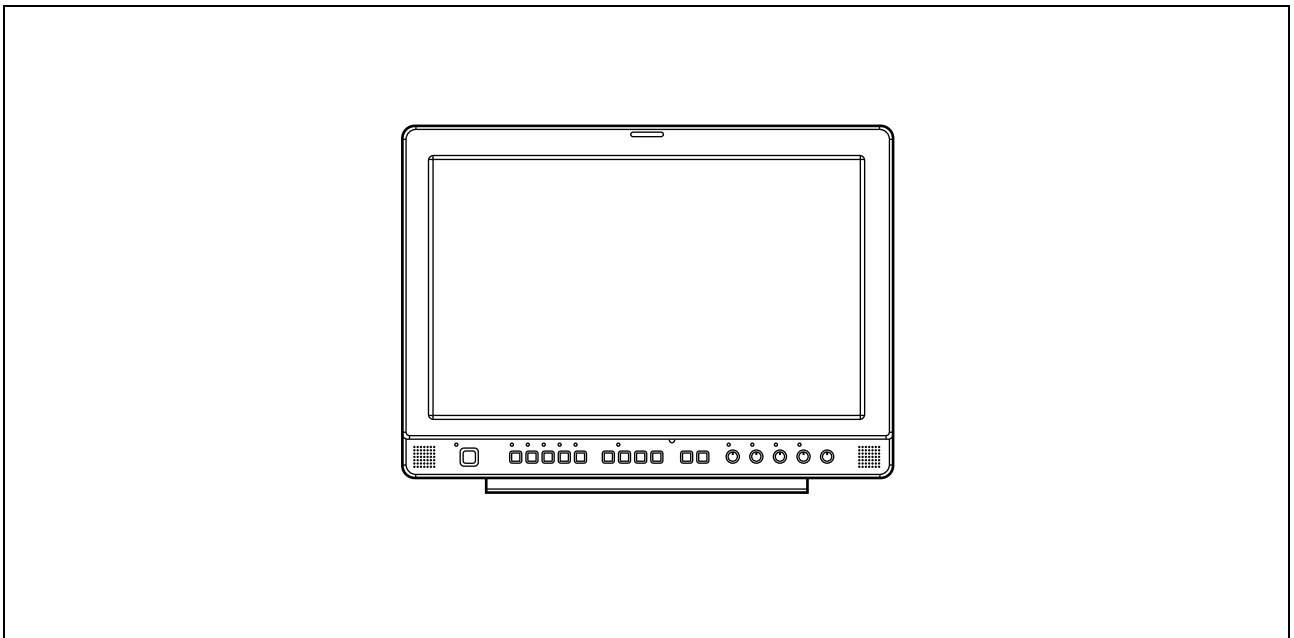

Before operating this product, please read the instructions carefully and save this manual for future use.

# For Your Safety



**CAUTION:** TO REDUCE THE RISK OF ELECTRIC SHOCK, DO NOT REMOVE COVER (OR BACK). NO USER-SERVICEABLE PARTS INSIDE. REFER SERVICING TO QUALIFIED SERVICE PERSONNEL.



The lightning flash with arrowhead symbol, within an equilateral triangle, is intended to alert the user to the presence of uninsulated "dangerous voltage" within the product's enclosure that may be of sufficient magnitude to constitute a risk of electric shock to persons.



The exclamation point within an equilateral triangle is intended to alert the user to the presence of important operating and maintenance (servicing) instructions in the literature accompanying the appliance.

## ■ THIS EQUIPMENT MUST BE GROUNDED

To ensure safe operation, the three-pin plug must be inserted only into a standard three-pin power outlet which is effectively grounded through normal household wiring. Extension cords used with the equipment must have three cores and be correctly wired to provide connection to the ground. Wrongly wired extension cords are a major cause of fatalities. The fact that the equipment operates satisfactorily does not imply that the power outlet is grounded or that the installation is completely safe.

For your safety, if you are in any doubt about the effective grounding of the power outlet, please consult a qualified electrician.

### **CAUTION:**

**THE AC RECEPTACLE (MAINS SOCKET OUTLET) SHALL BE INSTALLED NEAR THE EQUIPMENT AND SHALL BE EASILY ACCESSIBLE. TO COMPLETELY DISCONNECT THIS EQUIPMENT FROM THE AC MAINS, DISCONNECT THE POWER CORD PLUG FROM THE AC RECEPTACLE.**

### **WARNING:**

- TO REDUCE THE RISK OF FIRE OR SHOCK HAZARD, DO NOT EXPOSE THIS EQUIPMENT TO RAIN OR MOISTURE.
- TO REDUCE THE RISK OF FIRE OR SHOCK HAZARD, KEEP THIS EQUIPMENT AWAY FROM ALL LIQUIDS. USE AND STORE ONLY IN LOCATIONS WHICH ARE NOT EXPOSED TO THE RISK OF DRIPPING OR SPLASHING LIQUIDS, AND DO NOT PLACE ANY LIQUID CONTAINERS ON TOP OF THE EQUIPMENT.

### **CAUTION:**

In order to maintain adequate ventilation, do not install or place this unit in a bookcase, built-in cabinet or any other confined space. To prevent risk of electric shock or fire hazard due to overheating, ensure that curtains and any other materials do not obstruct the ventilation.

### **CAUTION:**

**TO REDUCE THE RISK OF FIRE OR SHOCK HAZARD AND ANNOYING INTERFERENCE, USE THE RECOMMENDED ACCESSORIES ONLY.**

### **CAUTION:**

This apparatus can be operated at a voltage in the range of 100 - 240 V AC.

Voltages other than 120 V are not intended for U.S.A. and Canada.

### **CAUTION:**

Operation at a voltage other than 120 V AC may require the use of a different AC plug. Please contact either a local or foreign Panasonic authorized service center for assistance in selecting an alternate AC plug.

### **Notice (U.S.A. only):**

**This product has a fluorescent lamp that contains a small amount of mercury. It also contains lead in some components. Disposal of these materials may be regulated in your community due to environmental considerations. For disposal or recycling information please contact your local authorities, or the Electronics Industries Alliance: <<http://www.eiae.org>>**

### **CAUTION:**

- Keep the temperature inside the rack to between 41°F to 95°F (5°C to 35°C).
- Bolt the rack securely to the floor so that it will not topple over.

 indicates safety information.

# For Your Safety (continued)

## FCC NOTICE (USA)

### Declaration of Conformity

Model Number: BT-LH1700WP  
Trade Name: PANASONIC  
Responsible Party: Panasonic Corporation of North America  
One Panasonic Way, Secaucus, NJ07094  
Support contact: Panasonic Broadcast & Television Systems Company  
1-800-524-1448

This device complies with Part 15 of FCC Rules.

Operation is subject to the following two conditions:

(1) This device may not cause harmful interference, and (2) this device must accept any interference received, including interference that may cause undesired operation.

To assure continued compliance, follow the attached installation instructions and do not make any unauthorized modifications.

### CAUTION:

This equipment has been tested and found to comply with the limits for a class B digital device, pursuant to Part 15 of the FCC Rules. These limits are designed to provide reasonable protection against harmful interference in a residential installation. This equipment generates, uses, and can radiate radio frequency energy, and if not installed and used in accordance with the instructions, may cause harmful interference to radio communications. However, there is no guarantee that interference will not occur in a particular installation. If this equipment does cause harmful interference to radio or television reception, which can be determined by turning the equipment off and on, the user is encouraged to try to correct the interference by one of the following measures:

- Reorient or relocate the receiving antenna.
- Increase the separation between the equipment and receiver.
- Connect the equipment into an outlet on a circuit different from that to which the receiver is connected.
- Consult the dealer or an experienced radio/TV technician for help.

The user may find the booklet "Something About Interference" available from FCC local regional offices helpful.

### FCC Warning:

To assure continued FCC emission limit compliance, the user must use only shielded interface cables when connecting to host computer or peripheral devices. Also, any unauthorized changes or modifications to this equipment could void the user's authority to operate this device.

## IMPORTANT SAFETY INSTRUCTIONS

- 1) Read these instructions.
- 2) Keep these instructions.
- 3) Heed all warnings.
- 4) Follow all instructions.
- 5) Do not use this apparatus near water.
- 6) Clean only with dry cloth.
- 7) Do not block any ventilation openings. Install in accordance with the manufacturer's instructions.
- 8) Do not install near any heat sources such as radiators, heat registers, stoves, or other apparatus (including amplifiers) that produce heat.
- 9) Do not defeat the safety purpose of the polarized or grounding-type plug. A polarized plug has two blades with one wider than the other. A grounding-type plug has two blades and a third grounding prong. The wide blade or the third prong are provided for your safety. If the provided plug does not fit into your outlet, consult an electrician for replacement of the obsolete outlet.
- 10) Protect the power cord from being walked on or pinched particularly at plugs, convenience receptacles, and the point where they exit from the apparatus.
- 11) Only use attachments/accessories specified by the manufacturer.
- 12) Use only with the cart, stand, tripod, bracket, or table specified by the manufacturer, or sold with the apparatus. When a cart is used, use caution when moving the cart/apparatus combination to avoid injury from tip-over.
- 13) Unplug this apparatus during lightning storms or when unused for long periods of time.
- 14) Refer all servicing to qualified service personnel. Servicing is required when the apparatus has been damaged in any way, such as power-supply cord or plug is damaged, liquid has been spilled or objects have fallen into the apparatus, the apparatus has been exposed to rain or moisture, does not operate normally, or has been dropped.



# Precautions for Use

---

- The liquid crystal portion is manufactured with highly precise technology. It includes over 99.99% effective pixels, but 0.01% or less of the pixels are either missing, or have fixed lighting (red, blue, green). This is not a sign of malfunction.
- The liquid crystal protection panel is a specially manufactured component. Wiping it with a hard cloth, or rubbing it vigorously will scratch the surface.
- If a still image is displayed for a long time, it may cause temporary generation of afterimage (phosphor burn-in). (However, these afterimages disappear when ordinary moving images are displayed for a while.)
- The response speed and brightness of liquid crystal vary with ambient temperatures.
- Consult with the authorized service person for the installation.  
Be sure to consult with the service person about the installation. Make sure that the wall or ceiling is strong enough to endure the weight of this unit including the mount fittings. If not strong enough, it may cause accidents such as falling off of the unit and injury.
- Do not install the unit in a place exposed to the direct sunlight. It may otherwise deteriorate the cabinet or damage the liquid crystal screen.

## Contents

---

<b>For Your Safety</b> . . . . .	<b>2</b>	<b>MARKER</b> . . . . .	<b>14</b>
<b>Precautions for Use</b> . . . . .	<b>4</b>	Types of MARKER . . . . .	15
<b>Standard accessories</b> . . . . .	<b>4</b>	<b>VIDEO CONFIG</b> . . . . .	<b>16</b>
<b>Optional units</b> . . . . .	<b>4</b>	<b>SYSTEM CONFIG</b> . . . . .	<b>17</b>
<b>Outline</b> . . . . .	<b>5</b>	GPI . . . . .	20
<b>Dimensions</b> . . . . .	<b>5</b>	<b>INPUT SELECT</b> . . . . .	<b>21</b>
<b>Controls and Their Functions</b> . . . . .	<b>6</b>	AUDIO . . . . .	22
Video monitor unit . . . . .	6	<b>CONTROL</b> . . . . .	<b>22</b>
Front panel . . . . .	7	<b>REMOTE Specifications</b> . . . . .	<b>23</b>
Rear panel . . . . .	8	<b>How to Attach the Rack mounting</b> . . . . .	<b>27</b>
<b>Power Supply</b> . . . . .	<b>9</b>	<b>Error/Warning Displays</b> . . . . .	<b>27</b>
<b>How to Use the On Screen Menu</b> . . . . .	<b>10</b>	<b>Maintenance</b> . . . . .	<b>27</b>
<b>User Data</b> . . . . .	<b>12</b>	<b>Maintenance Inspections</b> . . . . .	<b>28</b>
<b>Main Menu</b> . . . . .	<b>13</b>	<b>Specifications</b> . . . . .	<b>28</b>
Menu configuration . . . . .	13		

## Standard accessories

---

- |                     |           |
|---------------------|-----------|
| Power cord x 1      | Screw x 1 |
| Power cord hook x 1 |           |

## Optional units

---

- Rack-mounting adaptors** BT-MA1710G (Fitting instructions → page 27)
- Embedded Audio Unit** BT-YAE1700G (Fitting instructions → Installation Guide included)

# Outline

The BT-LH1700W liquid crystal monitor was designed especially for broadcasting service and business use. It is equipped with a high performance 17.1-inch wide liquid crystal display panel.

## ■ High performance liquid crystal panel

This monitor achieves outstanding color reproduction, a wide viewing angle, and high-speed response.

## ■ Immediate image output of input signals

The time-lag caused by IP field unit conversion<sup>\*1</sup> has been eliminated, and the delay from input until image output has been suppressed to the absolute minimum.

\*1 Conversion from interlace to progressive scanning.

## ■ Multi-format image compatibility

- This monitor is equipped with SDI (HD/SD compatible), VIDEO, Y/C, YP<sub>B</sub>P<sub>R</sub>/RGB input jacks.
- It supports both NTSC and PAL TV broadcast systems.

## ■ Screen display

You can divide the screen into two windows, and compare the windows using the same input terminal and same format. Furthermore, you can display a still image or WFM on one of the windows (→page 18 "SUB WINDOW", page 19 "About the SUB WINDOW").

## ■ REMOTE control

Depending on the intended use of the monitor, you can select between parallel remote control (GPI) and serial remote control (RS232C) (→page 23 – 26).

# Dimensions

Unit : mm (inches)

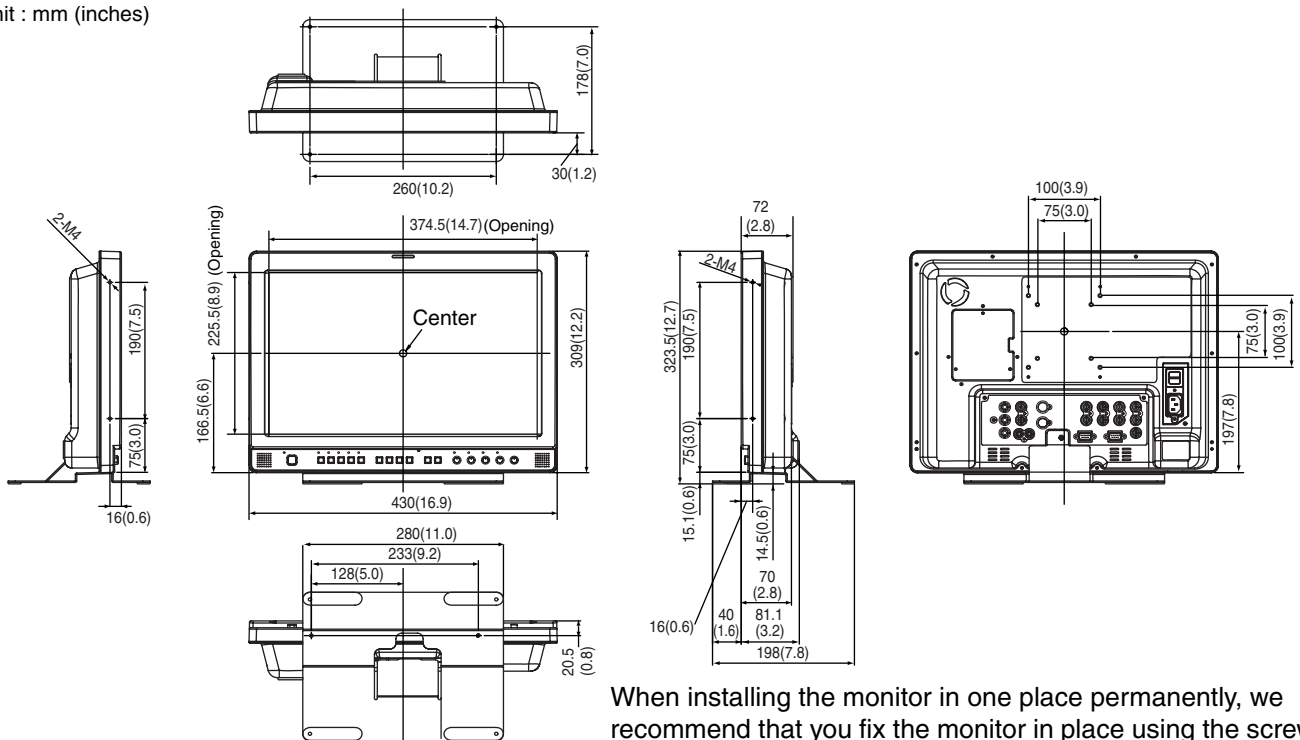

When installing the monitor in one place permanently, we recommend that you fix the monitor in place using the screw holes in the lower part of the stand.

# Controls and Their Functions

## Video monitor unit

### Front view

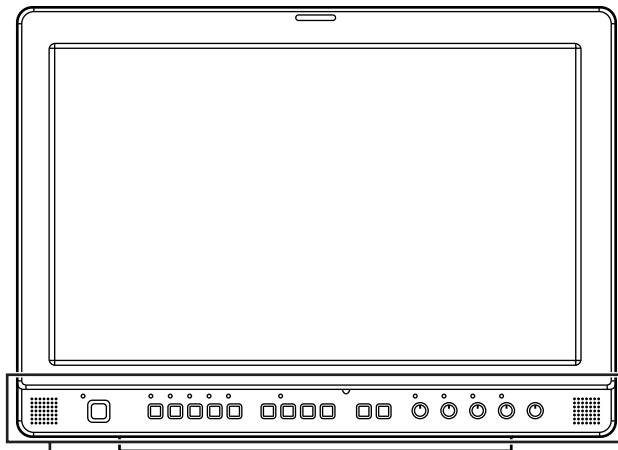

Front panel (→ page 7)

### Rear view

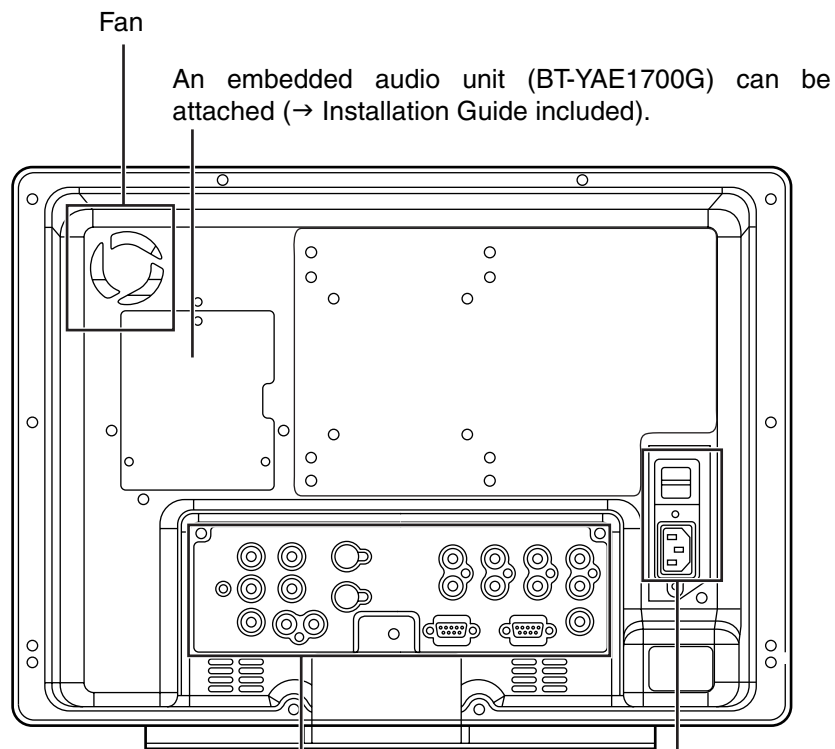

Rear panel (→ page 8)

Power supply [you can switch between AC and DC (→ page 9)]

# Controls and Their Functions (continued)

## Front panel

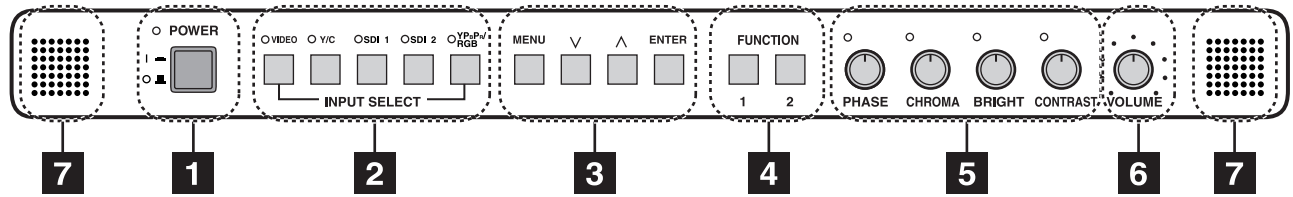

### 1 POWER switch

This switches the power supply ON/OFF. When the power is ON, the LED (green) lights up.

### 2 INPUT SELECT button

This selects the signal input line. The green LED light above the button indicates the selected input signal.

VIDEO : Video input

Y/C : Y/C input

SDI1 : Serial digital interface input (HD/SD compatible)

SDI2 : Serial digital interface input (HD/SD compatible)

YP<sub>BPr</sub>/RGB : Analog component (YP<sub>BPr</sub>) or RGB input. Also compatible with PC input RGB.

\* When using PC Input, select "RGB-COMP" from "YP<sub>BPr</sub>/RGB" in the "INPUT SELECT" menu (→page 21).

\* The monitor retains the input signal settings selected from the last time the monitor was switched ON or OFF.

### 3 MENU button

This is used for menu display, selecting settings, and adjustments.

MENU : Push to display or exit the menu, and to return to the previous menu screen.

↓, ↑ : Push to move the cursor up or down, or to select an item.

ENTER : Push to confirm a setting, and to display a submenu.

### 4 FUNCTION button

FUNCTION 1 : Carries out the item selected in the menu.

FUNCTION 2 : Carries out the item selected in the menu.

### 5 Picture adjusting knob

PHASE 0 – 60 (30)

CHROMA 0 – 60 (30)

BRIGHT 0 – 60 (30)

CONTRAST 0 – 60 (50)

( ) denotes factory preset values

A rotating knob that can be pushed to operate. You can display and adjust the menu settings by pushing the knob. The setting values are saved by pushing the knob again.

When values are changed from the factory preset values, the LED above the knob (amber) lights.

The setting values are loaded when the monitor's power is switched ON. The setting values are saved when the knob is pushed, or when 10 seconds pass after changing the settings. However, operating changes cannot be made in the following cases.

\* When the control lock is on, the key mark appears and setting values cannot be changed (→ page 22).

\* When the MONO function is ON (→ page 16), [PHASE] and [CHROMA] operations are disabled.

\* When using "RGB-COMP" input, [PHASE] and [CHROMA] operations are disabled.

\* While operating HV DELAY (→ page 17) (when set to any other setting than OFF), [BRIGHT] operation is disabled.

### 6 Volume knob

You can adjust the speaker volume by rotating the volume knob.

### 7 Speaker

Audio input from the AUDIO input terminal or SDI terminal (embedded audio) can be heard.

\* The BT-YAE1700G embedded audio unit (optional) must be attached to hear audio through embedded audio.

# Controls and Their Functions (continued)

## Rear panel

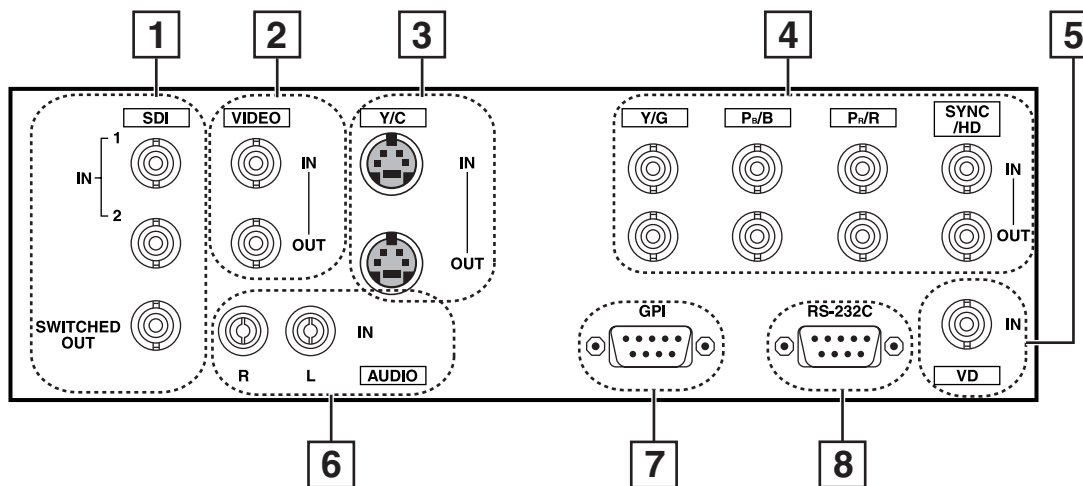

### 1 SDI (HD/SD) terminal (BNC)

IN1 : This is the SDI input terminal (compatible with HD/SD automatic switching).

IN2 : This is the SDI input terminal (compatible with HD/SD automatic switching).

SWITCHED OUT : This is the active through-out terminal for the SDI input signal being displayed on the screen.

\* SDI active through-out is only outputted when [SDI1] or [SDI2] is selected using the [INPUT SELECT] buttons. It is not outputted when anything other than SDI is selected.

### 2 VIDEO terminal (BNC)

IN : This is the VIDEO signal (composite signal) input terminal.

OUT : This is the input signal through-out terminal.

### 3 Y/C terminal

IN : This is the Y/C signal (S-video signal) input terminal.

OUT : This is the input signal through-out terminal.

### 4 YPbPr/RGB terminal (BNC)

IN : This is the YPbPr/RGB signal input terminal.

OUT : This is the input signal through-out terminal.

\* When using the RGB signal, you can also connect the external synchronizing signal to the SYNC/HD terminal. When using a PC RGB signal, connect the horizontal synchronizing signal to the SYNC/HD terminal, and the vertical synchronizing signal to the VD terminal.

### 5 VD IN input terminal

This is the vertical synchronizing signal (VD) input terminal used when connecting to a PC RGB signal.

### 6 AUDIO input terminal (Pin terminal)

This is the common audio input terminal for all video input terminals.

\* When an embedded audio unit BT-YAE1700G (optional) is attached, SDI input audio is automatically selected by selecting [SDI1] or [SDI2] with [INPUT SELECT].

### 7 GPI input terminal (D-SUB 9-pin)

External control is possible by using a GPI signal.

### 8 RS232C input terminal (D-SUB 9-pin)

External control is possible by using a RS232C signal.



# Power Supply

## Connecting and fixing the power cord

### 1. Attach the power cord to the monitor unit.

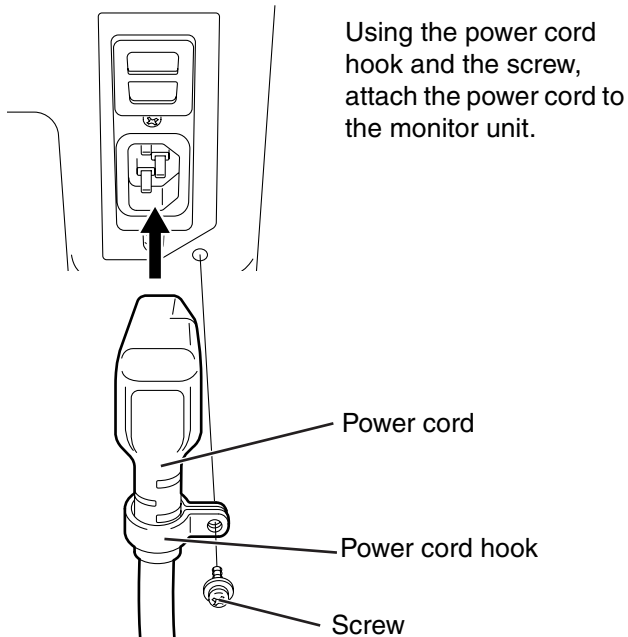

### 2. Connect the power cord to the power outlet.

### ■ When using external DC power (DC11V–17V)

You can slide open the power cover, and switch from AC input to external DC input. (When shipped from the factory, the power cover is up, and AC input is selected.)

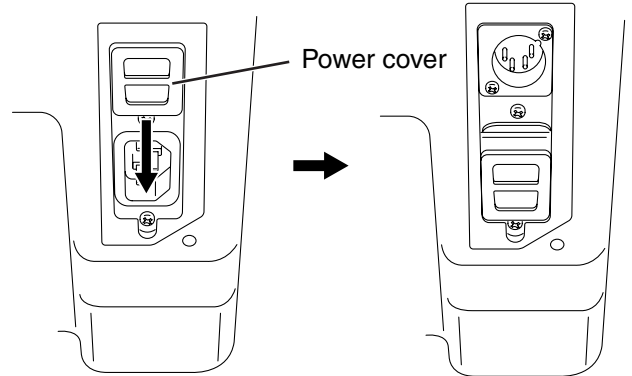

### Please note the following

If the power cover has been removed or opened, do not use the monitor with the power supply connected to both the AC input and external DC input terminals.

When using external DC power (DC11V–17V), check the external DC input terminal pin signal, and use the correct polarity. If a +12V power supply is accidentally connected to the GND terminal, this could cause a fire or personal injury.

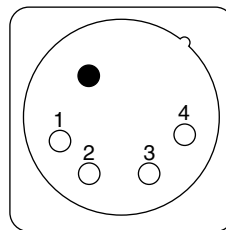

External DC input terminal

Pin number	Signal
1	GND
2, 3	—
4	+12V

# How to Use the On Screen Menu

Three types of information are displayed on the screen. The input signal status, picture adjusting knob status, and the menu display.

## Input signal status

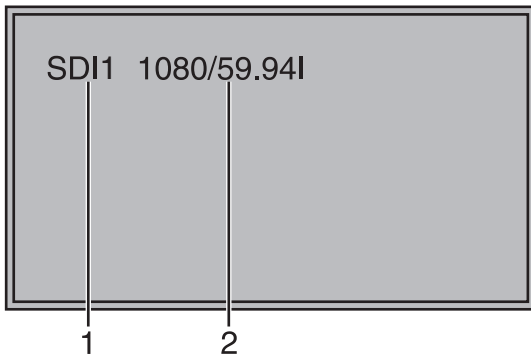

### 1. The selected input line (→ page 7, 2)

- VIDEO, Y/C, SDI1, SDI2, YPbPr/RGB-VIDEO/RGB-COMP.

### 2. Signal format

- The display status can be set in “STATUS DISPLAY” in the “SYSTEM CONFIG” menu (→ page 18).
- If “UNSUPPORT SIGNAL” is displayed, then either the current input signal is not supported or the “INPUT SELECT” menu setting needs to be changed.
- When “NO SIGNAL” is displayed, there is no input signal.

#### Note:

“UNSUPPORT SIGNAL” and “NO SIGNAL” may not be displayed correctly.

## Picture adjusting knob status

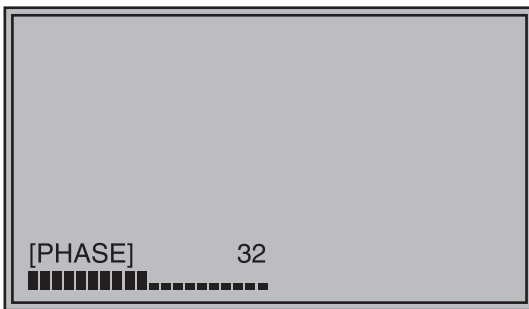

### Picture adjusting knob (→ page 7, 5)

- This knob can be rotated and pushed.
- The status display appears when the knob is pushed. The display disappears when the knob is pushed again, or if the knob is not operated for 10 seconds.
- Settings can only be adjusted in the status display.
- The display position can be changed (→ page 18 “ROTARY POSITION”).

Status display:

PHASE, CHROMA, BRIGHT, CONTRAST

#### Note:

The volume knob status display is not displayed on the screen.

## Menu display

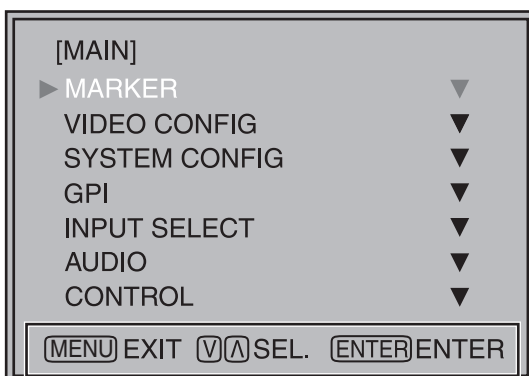

- This is displayed when the menu is used.
- The display disappears if remains idle for 2 minutes.
- The display position can be changed (→ page 18 “MENU POSITION”).

Displays the operation explanation for the menu button.

# How to Use the On Screen Menu (continued)

## Menu operations

1. Push [MENU] to display the MAIN menu.

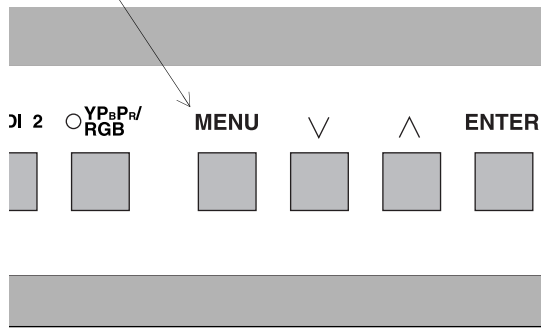

2. Push [V, ^] to select the menu, then push [ENTER].

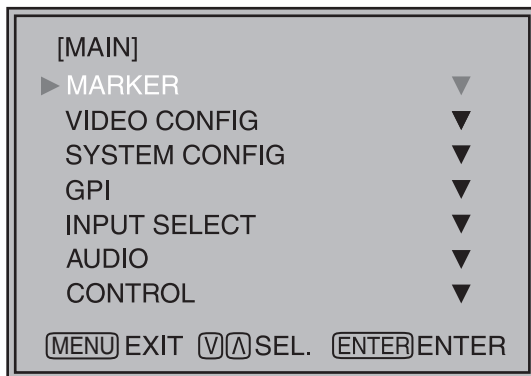

3. Push [V, ^] to select the sub menu, then push [ENTER].

The setting values in the sub menu change to green.

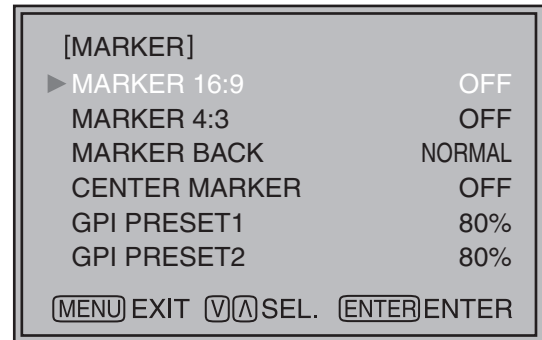

4. Push [V, ^] to select the setting values, then push [ENTER].

Push [MENU] to cancel.

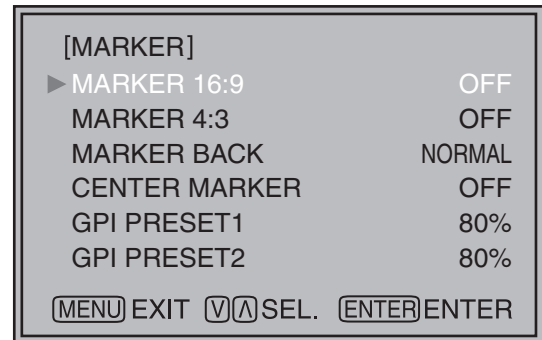

**To return to the previous screen**

Push [MENU].

# User Data

You can change the menu setting values and picture adjusting knob settings, then save and load up to 5 combinations of screen adjustment values as user data. You can also return the setting values and adjustment values to the factory preset settings.

The following settings are included in user data.

- Menu settings except for “SETUP LOAD/SAVE” (including the button function settings on the front of the monitor)
- Screen adjustment values changed in picture adjusting knob

## Saving user data

1. Push [MENU] to display the MAIN menu.
2. Push [V, ^] to select the “SYSTEM CONFIG” menu and push [ENTER].
3. Push [V, ^] to select the “SETUP SAVE” sub menu and push [ENTER].

The setting values in the sub menu change to green.

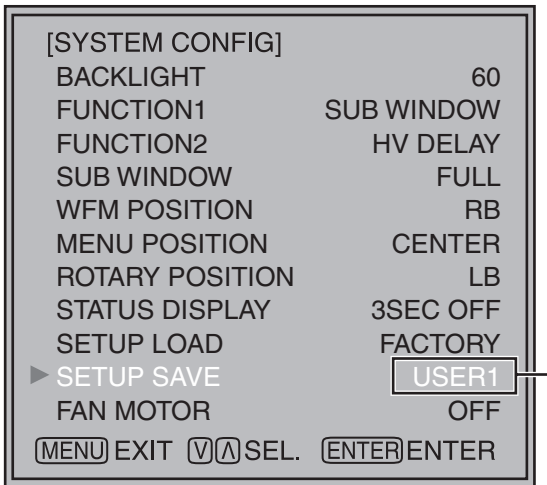

Changes to green

4. Push [V, ^] to select the file you wish to save to from “USER1” – “USER5”, then push [ENTER].

The following screen appears.

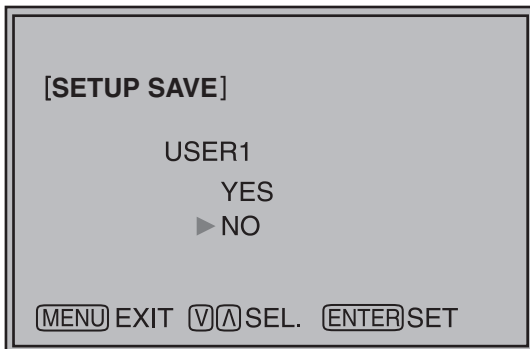

5. Select “YES”, and push [ENTER].

The user data is saved.

## Loading user data

1. Push [MENU] to display the MAIN menu.
2. Push [V, ^] to select the “SYSTEM CONFIG” menu and push [ENTER].
3. Push [V, ^] to select the “SETUP LOAD” sub menu and push [ENTER].

The setting values in the sub menu change to green.

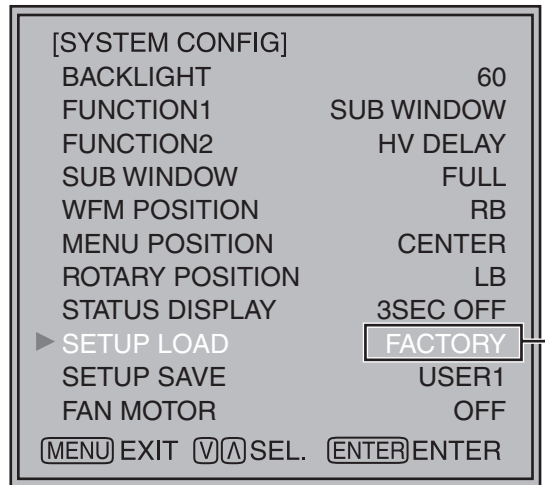

Changes to green

4. Push [V, ^] to select the file you wish to load to from “USER1” – “USER5”, then push [ENTER].

The following screen appears.

To return to the factory preset setting values, select “FACTORY”.

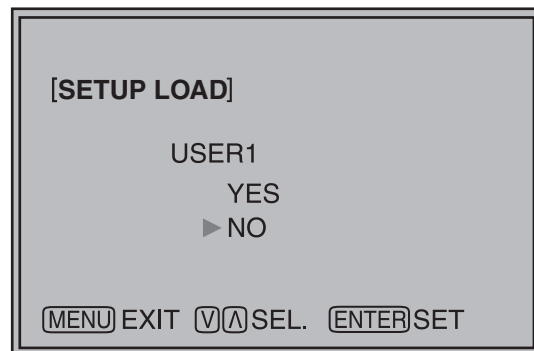

5. Select “YES”, and push [ENTER].

The user data is loaded.

**To return to the previous screen**

Push [MENU].

# Main Menu

## Menu configuration

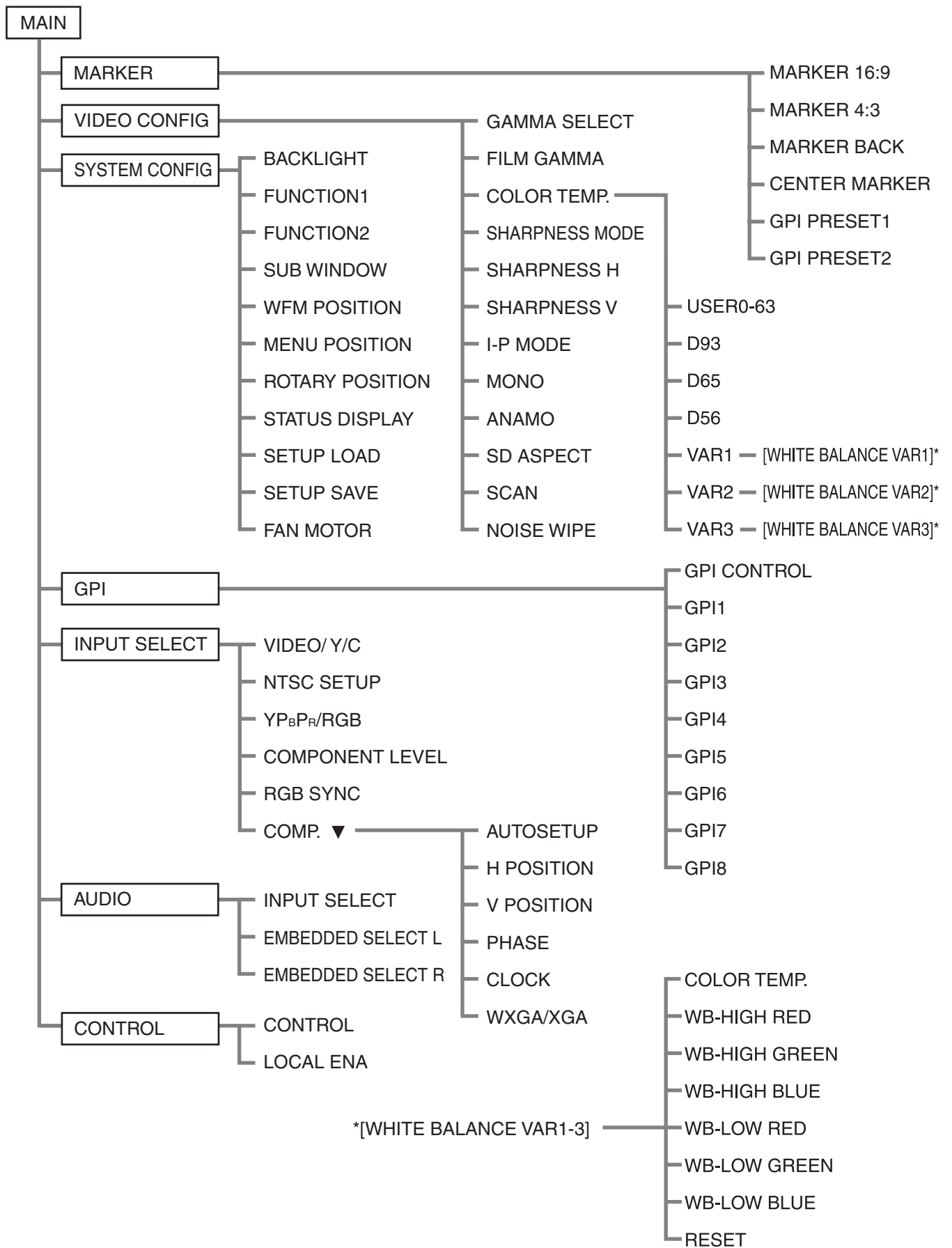

# Main Menu (continued)

## MARKER

The underlined values are factory preset setting values.

Sub menu	Settings	Explanation
<b>MARKER 16:9</b> <sup>*1*2</sup>	<u>&lt;OFF&gt;</u> <4:3 > <13:9> <14:9> <CNSCO> <VISTA> <95%> <93%> <90%> <88%> <80%>	Used to select/display the type of marker when the aspect ratio setting is 16:9.  <OFF> Marker not displayed. <4:3> 4:3 marker                      <13:9> 13:9 marker <14:9> 14:9 marker                   <CNSCO> CNSCO marker <VISTA> VISTA marker              <95%> 95% Area marker <93%> 93% Area marker              <90%> 90% Area marker <88%> 88% Area marker              <80%> 80% Area marker
<b>MARKER 4:3</b> <sup>*1*3</sup>	<u>&lt;OFF&gt;</u> <95%> <93%> <90%> <88%> <80%>	Used to select/display the type of marker when the aspect ratio setting is 4:3.  <OFF> Marker not displayed. <95%> 95% Area marker              <93%> 93% Area marker <90%> 90% Area marker              <88%> 88% Area marker <80%> 80% Area marker
<b>MARKER BACK</b> <sup>*1</sup>	<u>&lt;NORMAL&gt;</u> <HALF> <BLACK>	Used to select the background brightness excluding the marker. <NORMAL> Normal background <HALF> Background brightness 50% <BLACK> Background brightness 0% (Black)
<b>CENTER MARKER</b> <sup>*1</sup>	<u>&lt;OFF&gt;</u> <ON>	Used to display the center marker. <OFF> Not displayed <ON> Displayed
<b>GPI PRESET1</b>	<4:3 > <13:9> <14:9> <CNSCO> <VISTA> <95%> <93%> <90%> <88%> <u>&lt;80%&gt;</u>	Used to select the marker to be displayed using the GPI terminal "MARKER1 ON/OFF" operation (→ page 23).  <4:3> 4:3 marker                      <13:9> 13:9 marker <14:9> 14:9 marker                   <CNSCO> CNSCO marker <VISTA> VISTA marker              <95%> 95% Area marker <93%> 93% Area marker              <90%> 90% Area marker <88%> 88% Area marker              <80%> 80% Area marker
<b>GPI PRESET2</b>	<4:3 > <13:9> <14:9> <CNSCO> <VISTA> <95%> <93%> <90%> <88%> <u>&lt;80%&gt;</u>	Used to select the marker to be displayed using the GPI terminal "MARKER2 ON/OFF" operation (→ page 23).  <4:3> 4:3 marker                      <13:9> 13:9 marker <14:9> 14:9 marker                   <CNSCO> CNSCO marker <VISTA> VISTA marker              <95%> 95% Area marker <93%> 93% Area marker              <90%> 90% Area marker <88%> 88% Area marker              <80%> 80% Area marker

\*1 When controlling the marker settings using the GPI function (→ page 23), these settings become disabled. These are not operated when the 2 screens are displayed.

\*2 These are only enabled when the HD signal and SD signal aspect ratio settings are 16:9.

\*3 These are only enabled when the SD signal aspect ratio setting is 4:3.

# Main Menu (continued)

## Types of MARKER

### ■ 16:9 marker

(Displayed when using HD, or when using SD with a 16:9 aspect ratio)

The marker is only displayed as a vertical bar. In addition, the  section becomes the "MARKER BACK" item.



4:3 marker



13:9 marker



14:9 marker

### VISTA marker, CNSCO marker

A horizontal dotted line is displayed as the marker.



VISTA marker

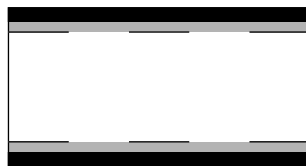

CNSCO marker

When "UNDER" is set in "SCAN" in the "VIDEO CONFIG" menu, a vertical dotted line is also displayed as the marker.



VISTA marker



CNSCO marker

### Area marker

A dotted line is displayed as the marker.

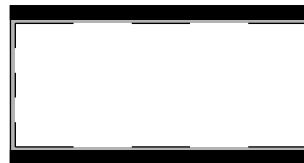

95% Area marker



93% Area marker



90% Area marker



88% Area marker



80% Area marker

### ■ 4:3 marker

(Displayed when using SD with a 4:3 aspect ratio)

A dotted line is displayed as the marker.

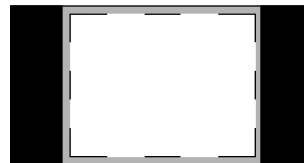

95% Area marker

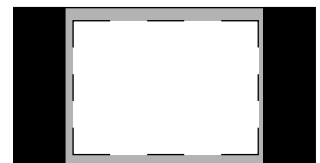

93% Area marker

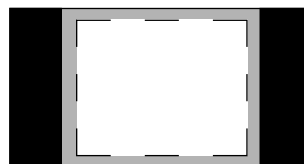

90% Area marker

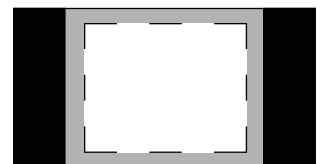

88% Area marker

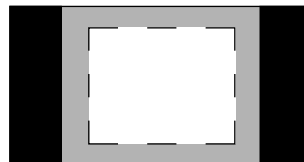

80% Area marker

### ■ Center marker

The marker is displayed in the center of the picture.

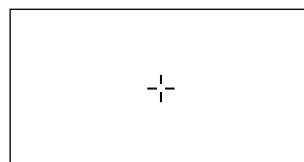

Center marker

# Main Menu (continued)

## VIDEO CONFIG

The underlined values are factory preset setting values.

Sub menu	Settings	Explanation
<b>GAMMA SELECT</b> <sup>*2</sup>	< <u>NORMAL</u> > <FILM> <sup>*1</sup>	Used to select the gamma curve. When FILM is selected,  <b>FILM</b> mark is displayed in the top left of the screen.
<b>FILM GAMMA</b> <sup>*2</sup>	< <u>VARICAM</u> > <OTHER>	Used to select the type of FILM gamma mode. <VARICAM> VARICAM use <OTHER> When using other types than VARICAM
<b>COLOR TEMP.</b>	<USER0-63> <sup>*5</sup> <D93> <D65> <D56> <VAR1> <VAR2> <VAR3>	Used to select the color temperature. <USER0-63> Adjustable settings 0-63 (color temperature around 3000K-9300K) <D93> Color temperature around 9300K <D65> Color temperature around 6500K <D56> Color temperature around 5600K <VAR1> WB adjustment mode <sup>*4</sup> <VAR2> WB adjustment mode <sup>*4</sup> <VAR3> WB adjustment mode <sup>*4</sup>
<b>SHARPNESS MODE</b> <sup>*2</sup>	<HIGH> <sup>*3</sup> <LOW>	Used to select the width of the sharpness edge. <HIGH> Thin edge      <LOW> Thick edge
<b>SHARPNESS H</b> <sup>*2</sup>	<0-30> <sup>*3</sup>	Used to set the sharpness in the horizontal direction. When adjusting, the item display moves to the lower part of the screen.
<b>SHARPNESS V</b> <sup>*2</sup>	<0-30> <sup>*3</sup>	Used to set the sharpness in the vertical direction. When adjusting, the item display moves to the lower part of the screen.
<b>I-P MODE</b> <sup>*2</sup>	<MODE2> <MODE1>	Used to set the mode for IP change. <MODE2> Within Field      <MODE1> Normal mode
<b>MONO</b> <sup>*2</sup>	<OFF> <ON>	Used to switch between color and monochrome (MONO). <OFF> Color      <ON> Monochrome * When this is ON, the picture adjusting knob [CHROMA] setting is fixed at 0.
<b>ANAMO</b> <sup>*2</sup>	<OFF> <ON>	If an Anamo lens has been used on the camera, and input through SDI 720/60P, 59.94P, the picture is resized to Anamo size magnification. (a vertically compressed signal can be amplified vertically and corrected when it is displayed.)
<b>SD ASPECT</b> <sup>*2</sup>	<4:3> <16:9>	Used for setting the aspect ratio settings when using SD signal input. <4:3> 4:3 display      <16:9> 16:9 display
<b>SCAN</b> <sup>*2</sup>	< <u>NORMAL</u> > <UNDER>	Used to set under-scan and normal display. <NORMAL> Normal display      <UNDER> Under-scan
<b>NOISE WIPE</b> <sup>*2</sup>	<OFF> <ON>	<OFF> This makes a fluid and smooth contrast obtainable. This is especially effective for continuously changing the contrast of the source signal or CG signal when the S/N is very high. <ON> Noise reduction mode. Depending on the camera, this mode can be especially effective for dark scenes. We recommend leaving this setting "ON" under normal conditions.

\*1 Even if FILM gamma is changed during 2 screen display, only the main window is set, and the changes are not reflected in the sub window.

\*2 When "RGB-COMP." is selected in "YP<sub>B</sub>P<sub>R</sub>/RGB" in the "INPUT SELECT" menu (→ page 21), this does not operate.

\*3 The following sharpness values can each be set,

1) VIDEO system input line (VIDEO,Y/C)(Factory settings are SHARPNESS MODE : LOW, SHARPNESS H/V : 0)

2) any other input line's HD (Factory settings are SHARPNESS MODE : HIGH, SHARPNESS H/V : 0)

3) any other input line's SD (Factory settings are SHARPNESS MODE : LOW, SHARPNESS H/V : 0) and the setting values for the selected input signal from within this group is displayed. The adjustment status is displayed in the bottom right when selected.

\*4 When "VAR1", "VAR2" or "VAR3" is selected, the monitor switches to WB adjustment mode (→ page 17).

\*5 When selecting USER0-63

1) Push [ENTER] (USER changes to blue).

2) Select 0-63 with [V, ^], and push [ENTER].



## Main Menu (continued)

### ■ WB adjustment mode

You can adjust “WHITE BALANCE VAR1” – “WHITE BALANCE VAR3” (WB) by selecting “VAR1” – “VAR3” in “COLOR TEMP.” in the “VIDEO CONFIG” menu.

The underlined values are factory preset setting values.

Sub menu	Settings	Explanation
<b>COLOR TEMP.</b>	<USER0–63> <D93> <D65> <D56>	Used to select the color temperature that will become the basis for adjustments. <USER0–63> Adjustable settings 0–63 (color temperature around 3000K–9300K) <D93> Color temperature around 9300K <D65> Color temperature around 6500K <D56> Color temperature around 5600K
<b>WB-HIGH RED</b>	<0–60> (Factory preset settings: 30)	Used to adjust the WB in the HIGH level R component.*1
<b>WB-HIGH GREEN</b>		Used to adjust the WB in the HIGH level G component.*1
<b>WB-HIGH BLUE</b>		Used to adjust the WB in the HIGH level B component.*1
<b>WB-LOW RED</b>		Used to adjust the WB in the LOW level R component.*1
<b>WB-LOW GREEN</b>		Used to adjust the WB in the LOW level G component.*1
<b>WB-LOW BLUE</b>		Used to adjust the WB in the LOW level B component.*1
<b>RESET</b>		This returns the “WB-HIGH RED” – “WB-LOW BLUE” settings to the factory presets.

\*1 When adjusting, the item display moves to the lower part of the screen.

## SYSTEM CONFIG

The underlined values are factory preset setting values.

Sub menu	Settings	Explanation
<b>BACKLIGHT</b>	< 0– <u>60</u> >	Used to adjust the brightness of the liquid crystal backlight.
<b>FUNCTION1</b>	<HV DELAY> <AUTOSETUP> <BLUE ONLY> <GAMMA SELECT> <SD ASPECT> <SCAN> <SUB WINDOW> <UNDEF>	Used to select the functions assigned to [FUNCTION1] and [FUNCTION2] (front buttons). <HV DELAY> <sup>*2</sup> Displays the synchronizing signal (horizontal, vertical). The display is switched in the following order. OFF → H-Delay → V-Delay → HV-Delay → OFF <AUTOSETUP> <sup>*5</sup> Used to automatically adjust the PC display. <BLUE ONLY>
<b>FUNCTION2</b>	<HV DELAY> <AUTOSETUP> <BLUE ONLY> <GAMMA SELECT> <SD ASPECT> <SCAN> <SUB WINDOW> <UNDEF>	Used to cut the red and green signals. You can check the hue (PHASE) and depth of color (CHROMA). This is switched between ON/OFF by pushing the button. <GAMMA SELECT> You can switch between “NORMAL” and “FILM”. <sup>*3*4</sup> <SD ASPECT> Used to switch between “16:9” and “4:3”. <sup>*3*4</sup> <SCAN> You can switch between “UNDER” and “NORMAL”. <sup>*3*4</sup> <SUB WINDOW> You can perform the settings for 2 screen display mode. <sup>*3*4*6</sup> <UNDEF> No settings

\*2 This function is disabled while in 2 screen display mode.

\*3 These functions are disabled when the control settings are in GPI mode.

\*4 If these settings are changed, the menu settings will also change.

\*5 When “RGB-COMP.” is not selected in “YPbPr/RGB” in the “INPUT SELECT” menu, “NOT RGB-COMP.CH-” is displayed, and this does not operate.

\*6 This function will not work when “RGB-COMP.” is selected in “YPbPr/RGB” in the “INPUT SELECT” menu.

# Main Menu (continued)

## SYSTEM CONFIG

The underlined values are factory preset setting values.

Sub menu	Settings	Explanation
<b>SUB WINDOW</b>	< <u>FULL</u> > <PART> <WFM>	Used to select the type of sub window. <FULL> Used to reduce the whole input signal screen, and arrange it horizontally when it is displayed. <PART> Used to cut out the central section of the input signal screen, and arrange it horizontally when it is displayed (Displayed at the same size as the previous screen). <WFM> Used to display the waveform display screen.*2
<b>WFM POSITION</b>	<LB> < <u>RB</u> > <RT> <LT>	Used to set the WFM display position. <LB> Bottom left of the screen    <RB> Bottom right of the screen <RT> Top right of the screen    <LT> Top left of the screen
<b>MENU POSITION</b>	< <u>CENTER</u> > <LB> <RB> <RT> <LT>	Used to set the on screen menu display position. <CENTER> Center of the screen <LB> Bottom left of the screen    <RB> Bottom right of the screen <RT> Top right of the screen    <LT> Top left of the screen
<b>ROTARY POSITION</b>	<CENTER> < <u>LB</u> > <RB> <RT> <LT>	Used to set the picture adjusting knob status (on screen menu) display position. <CENTER> Center of the screen <LB> Bottom left of the screen    <RB> Bottom right of the screen <RT> Top right of the screen    <LT> Top left of the screen
<b>STATUS DISPLAY</b>	<CONTINUE> < <u>3SEC OFF</u> > <OFF>	Used to set the input signal status (on screen menu) display status. <CONTINUE> Displayed normally. <3SEC OFF> After changing status, it is displayed for approximately 3 seconds, and then disappears. <OFF> Not displayed.
<b>SETUP LOAD</b>	< <u>FACTORY</u> > <USER1> *1 <USER2> *1 <USER3> *1 <USER4> *1 <USER5> *1	The saved factory preset setting values (FACTORY) or the user data (USER 1–USER 5) are loaded. Also after loading user data, the screen displays the signal selected before loading data.
<b>SETUP SAVE</b>	<USER1> <USER2> <USER3> <USER4> <USER5>	Up to 5 sets of user data can be saved (→ page 12). The menu settings and picture adjusting knob adjustment values (PHASE /CHROMA /BRIGHT /CONTRAST) excluding “SETUP SAVE/ SETUP LOAD” are saved.
<b>FAN MOTOR</b>	< <u>OFF</u> > <ON>	Used to set fan operation. <OFF> The fan is stopped. The brightness of the backlight automatically lowers. <ON> The fan operates. The backlight brightness returns to normal.

\*1 When the monitor is shipped from the factory, “USER1” – “USER5” and “FACTORY” all have the same details.

\*2 This screen is not displayed when “RGB-COMP” is selected in the “Y<sub>B</sub>P<sub>R</sub>/RGB” menu in the “INPUT SELECT” menu.

### ■ About H/V DELAY

This displays the video blanking period. By pushing the button, you can switch through the H blanking display → V blanking display → H and V blanking display → no blanking display.

# Main Menu (continued)

## ■ About the SUB WINDOW

You can compare saved still and moving images or show the Wave Form Monitor (WFM) by using the “SUB WINDOW” function to separate the main window into 2 displays as shown below.

Depending on the settings of the “SUB WINDOW” (FULL, PART, WFM) in the “SYSTEM CONFIG” menu (→ page 18) it can be switched as shown below.

Every time you press the [FUNCTION1] (or [FUNCTION2]) button (→ page 17) assigned to the “SUB WINDOW” function, the window switches (To use the “SUB WINDOW” function, assign it to [FUNCTION1] or [FUNCTION2]).

### • FULL

The main window is reduced and made into 2 sub window (sub window+sub window).

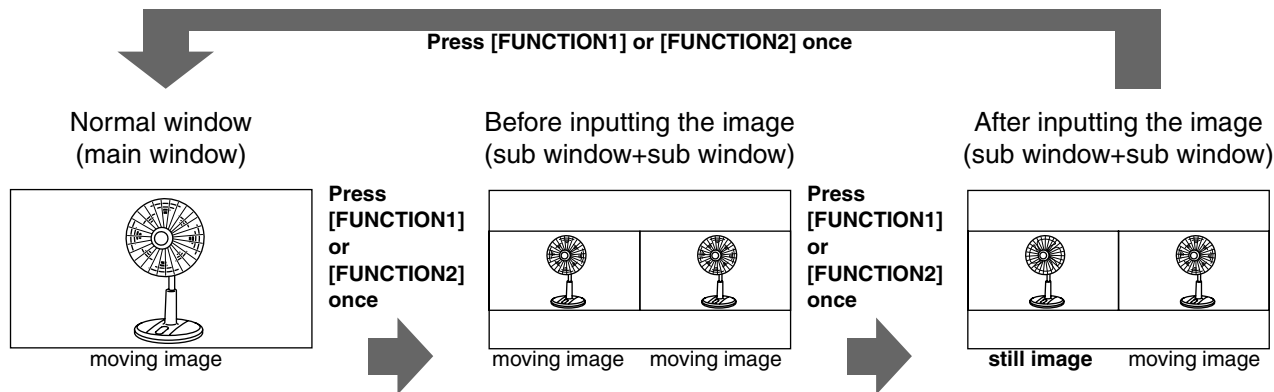

### • PART

Only the sub window size is cut out of the main window, and the cut section is made into 2 sub window images (sub window+sub window).

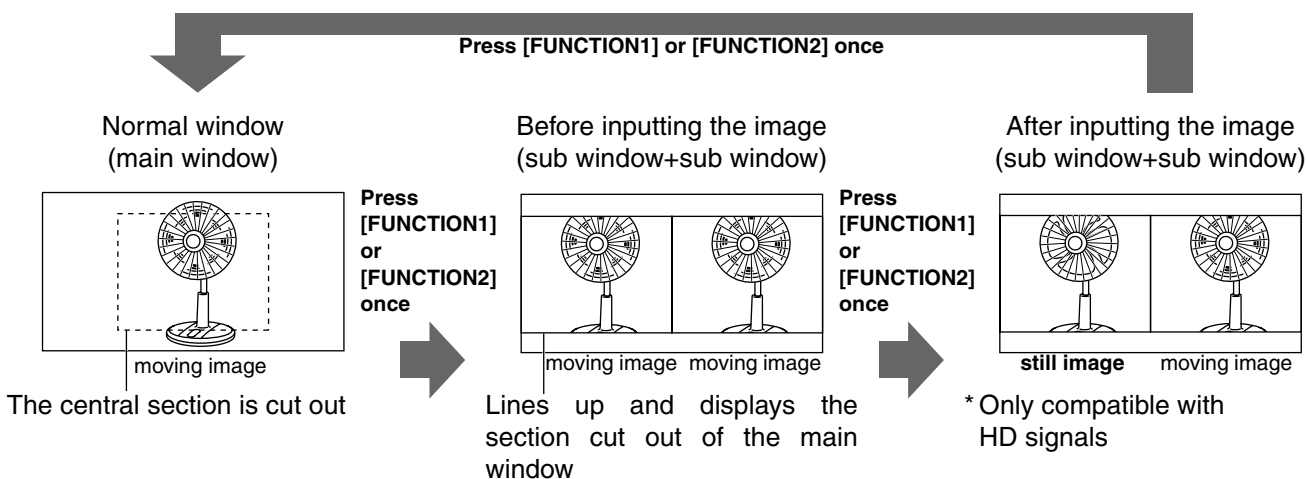

### • WFM

Displays the Wave Form Monitor image

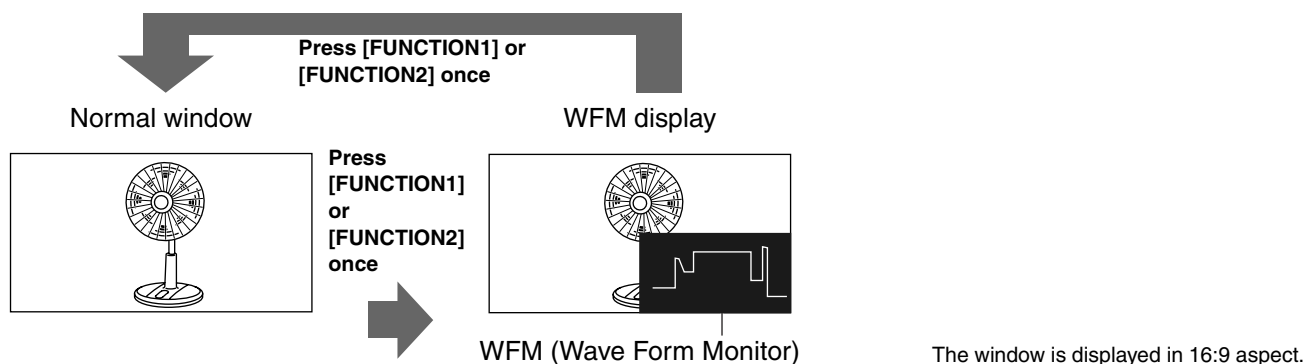

### Precautions when selecting FULL/PART

This function compares screens with the same input terminal and same format. If different input formats, or if signals are input between different input channels, the sub-window (left side, still image) becomes blurred and blanking occurs. However, if the same format signals are input into the input terminal when acquiring the still image, the images will be displayed correctly.

## Main Menu (continued)

### GPI

The “GPI CONTROL” item is used to set enable/disable of all GPI functions, and assigns functions to each of the GPI terminal pins (→ page 23).

The underlined values are factory preset setting values.

Sub menu	Settings	Explanation
<b>GPI CONTROL</b>	< <u>DISABLE</u> > <ENABLE>	GPI functions enable/disable settings
<b>GPI1–GPI8</b>	< <u>UNDEF</u> > <MARKER1 ON/OFF> <MARKER2 ON/OFF> <MARKER BACKHALF> <MARKER BACKBLACK > <CENTER MARKER> <INPUT SEL. VIDEO> <INPUT SEL. Y/C> <INPUT SEL. SDI1> <INPUT SEL. SDI2> <INPUT SEL. YP <sub>B</sub> P <sub>R</sub> /RGB> <SD ASPECT> <SCAN> <R-TALLY> <G-TALLY> <MONO> <GAMMA SELECT> <RGB SYNC>	Used to set the GPI control terminal pin assign. You can set the same items for each terminal (refer to page 23 for details).

#### Note:

Please be aware that the following can not be performed.

- “SD ASPECT” operation when input signal is HD or PC
- “SCAN” operation when the input signal is PC
- “GAMMA SELECT” operation when the input signal is PC
- “RGB SYNC” operation when anything other than “RGB-VIDEO” is selected in “YP<sub>B</sub>P<sub>R</sub>/RGB” in the “INPUT SELECT” menu
- “MONO” operation when input signal is PC

## Main Menu (continued)

### INPUT SELECT

The underlined values are factory preset setting values.

Sub menu	Settings	Explanation
<b>VIDEO / Y/C</b>	<u>&lt;AUTO&gt;</u> <NTSC> <PAL>	Used to select the input format for VIDEO and Y/C input. *1 <AUTO> Either NTSC or PAL is automatically selected. <NTSC> NTSC            <PAL> PAL
<b>NTSC SETUP</b>	<75> <u>&lt;00&gt;</u>	Selects the NTSC setup level. <75> Select this when using with a setup signal of 7.5 IRE. (The inner parts of the monitor are set to the 7.5 IRE setup level to suit the black level) <00> Select this when there is no setup level signal.
<b>YP<sub>B</sub>Pr/RGB</b>	<u>&lt;YP<sub>B</sub>Pr&gt;</u> <RGB-VIDEO> <RGB-COMP.>	Selects either YP <sub>B</sub> Pr (Component) or RGB input mode. <YP <sub>B</sub> Pr> Selects the YP <sub>B</sub> Pr signal. <RGB-VIDEO> Selects the video RGB signal. <RGB-COMP.> Selects the PC RGB signal.
<b>COMPONENT LEVEL</b>	<u>&lt;SMPTE&gt;</u> <B75> <B00>	Selects YP <sub>B</sub> Pr (Component) signal input level. <SMPTE> When the signal level specified in SMPTE is Chroma 100 IRE P <sub>B</sub> , P <sub>R</sub> = 0.7 Vp-p. <B75> Select this when connecting a betacam or similar devices set to 7.5 IRE. (The inner parts of the monitor are set at 7.5 IRE setup level to suit the black level) <B00> Select this when connecting a betacam or similar devices that are not setup to the IRE level.
<b>RGB SYNC</b>	<u>&lt;G-ON&gt;</u> <EXT>	Selects the SYNC when using RGB-VIDEO input. <G-ON> Select when a synchronizing signal is superimposed on the G signal. <EXT> Select when an external synchronizing signal is received in synchronization.
<b>COMP.</b>	▼	Performs analog PC settings. (Refer to "COMP" below)

\*1 "AUTO" is set when the monitor is shipped from the factory, but if there are concerns about noise etc. from outside the input signal, we recommend assigning specific format.

### ■ COMP.

The following menus are switched by selecting "RGB-COMP" in "YP<sub>B</sub>Pr/RGB" in the "INPUT SELECT" menu.

The underlined values are factory preset setting values.

Sub menu	Settings	Explanation
<b>AUTOSETUP</b> *1		Screen automatic adjustment is performed when "RGB-COMP" is selected in "YP <sub>B</sub> Pr/RGB" in the "INPUT SELECT" menu. "AUTOSETUP" is performed if a different screen is displayed, and "YES" is selected.
<b>H POSITION</b>	<0-60> (Factory preset settings: 30)	Used to adjust the picture display position in the horizontal direction. *2
<b>V POSITION</b>	<0-60> (Factory preset settings: 30)	Used to adjust the picture display position in the vertical direction. *2
<b>PHASE</b>	<0-31> (Factory preset settings: → page 22)	Used to adjust the clock phase with 1/32 clock phases. *2
<b>CLOCK</b>	<700-1800> (Factory preset settings: → page 22)	Used to adjust the sampling clock in dot units. *2
<b>WXGA/XGA</b>	<u>&lt;XGA&gt;</u> <WXGA>	Switches between WXGA and XGA.

\*1 "EXECUTING" is displayed while "AUTOSETUP" is being executed, and "COMPLETE" is displayed when "AUTOSETUP" is completed.

If "AUTOSETUP" cannot be completed, "INCOMPLETE" is displayed.

\*2 Each RGB-COMP. input compatible format can be adjusted.

## Main Menu (continued)

### ■ “PHASE” and “CLOCK” factory preset setting values

FORMAT	CLOCK	PHASE	FORMAT	CLOCK	PHASE
640x400(70Hz)	800	18	1024x768(60Hz)	1344	2
640x480(60Hz)	800	17	1024x768(70Hz)	1328	22
640x480(75Hz)	840	10	1024x768(75Hz)	1312	16
640x480(85Hz)	832	5	1024x768(85Hz)	1376	17
800x600(60Hz)	1056	31	1280x768(60Hz)	1728	8
800x600(75Hz)	1056	12	1280x768(75Hz)	1712	31
800x600(85Hz)	1048	29	1280x1024(60Hz)	1688	20

### AUDIO

Adjusting the speaker output. This can only be set when the monitor is equipped with an embedded audio unit BT-YAE1700G (optional). If the monitor is not equipped with an embedded audio unit, the output will be in analog.

The underlined values are factory preset setting values.

Sub menu	Settings	Explanation
<b>INPUT SELECT</b>	<AUTO> <ANALOG> <EMBEDDED>	Used to select speaker output. <AUTO> When SDI input line is selected (front panel) : embedded audio (SDI terminal) When any other line than SDI input line is selected (front panel) : analog (AUDIO input terminal) <ANALOG> Analog (AUDIO input terminal) <EMBEDDED> When SDI input line is selected (front panel) : embedded audio (SDI terminal) When any other line than SDI input line is selected (front panel) : No sound
<b>EMBEDDED SELECT L</b>	<CH1-CH8> (Factory preset settings: CH1)	Used to select the audio channel of the embedded audio outputted to the left speaker.
<b>EMBEDDED SELECT R</b>	<CH1-CH8> (Factory preset settings: CH2)	Used to select the audio channel of the embedded audio outputted to the right speaker.

### CONTROL

The underlined values are factory preset setting values.

Sub menu	Settings	Explanation
<b>CONTROL</b>	<LOCAL> <REMOTE>	Used to select the operation. (Combined control lock) <LOCAL> Front operation enabled <REMOTE> Remote operation enabled (The front controls become locked) <sup>*1</sup>
<b>LOCAL ENA<sup>*2</sup></b>	<DIS.> <INPUT>	When “REMOTE” is selected in “CONTROL”, this selects whether front controls are enabled/disabled. <DIS.> All front operations are disabled. <INPUT> All controls except for the [INPUT SELECT] button and volume knob are disabled.

\*1 The menu can be displayed when the lock is engaged.

The only menu setting that can be changed when the lock is engaged is the “CONTROL/LOCAL ENA” item.

When the lock is engaged, the picture adjusting knob is disabled.

Operations when the lock is engaged follow the settings in “LOCAL ENA”.

When the lock is engaged, the volume knob can be operated (→ page 7, **6**).

When the lock is engaged, the key mark is displayed on the screen.



\*2 This is only enabled when “CONTROL” is set to “REMOTE”.

# REMOTE Specifications

REMOTE operation is possible on this monitor using the GPI/RS-232C terminal.

## GPI terminal

Each of the items in the GPI screen are compatible with the following terminals.

You can assign functions to each terminal in the menu GPI screen (→ page 20).

The functions assigned to each terminal operate when the GND (5 Pin) is connected (ON) or open (OFF).

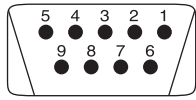

GPI Terminal (9P)

Pin number	Signal
1	GPI1
2	GPI2
3	GPI3
4	GPI4
5	GND
6	GPI5
7	GPI6
8	GPI7
9	GPI8

### ■ Operating conditions

Level operation: operates when GND is connected.

Edge operation: operates when GND changes from open to connected.

\* If you have assigned a level operation function to more than one terminal, the function operates as long as one of the terminals is connected.

Assignment items	Function	Operating conditions
<b>UNDEF</b>	No settings (no terminal assignment functions)	—
<b>MARKER1 ON/OFF</b>	Switches the marker display of the marker decided in "GPI PRESET1" (→ page 14) in the "MARKER" menu.	Level operation (Connected: ON, Open: OFF)
<b>MARKER2 ON/OFF</b>	Switches the marker display of the marker decided in "GPI PRESET2" (→ page 14) in the "MARKER" menu.	Level operation (Connected: ON, Open: OFF)
<b>MARKER BACKHALF</b>	Reduces the brightness of the background outside the marker displayed in "GPI PRESET1" (→ page 14) by 50%.	Level operation (Connected: ON, Open: OFF)
<b>MARKER BACKBLACK</b>	Reduces the brightness of the background outside the marker displayed in "GPI PRESET1" (→ page 14) to 0%.	Level operation (Connected: ON, Open: OFF)
<b>CENTER MARKER</b>	Switches the center marker display ON/OFF. (When other markers are being displayed, this is superimposed on the other markers)	Level operation (Connected: ON, Open: OFF)
<b>INPUT SEL. VIDEO</b>	Switches the input system to VIDEO.	Edge operation
<b>INPUT SEL. Y/C</b>	Switches the input system to Y/C.	Edge operation
<b>INPUT SEL. SDI1</b>	Switches the input system to SDI1.	Edge operation
<b>INPUT SEL. SDI2</b>	Switches the input system to SDI2.	Edge operation
<b>INPUT SEL. YP<sub>BPr</sub>/RGB</b>	Switches the input system to YP <sub>BPr</sub> /RGB.	Edge operation
<b>SD ASPECT</b>	Sets the aspect ratio settings when using SD signal input. (Disabled when using HD signal and PC signal)	Level operation (Connected: 16:9, Open: 4:3)
<b>SCAN</b>	You can switch the scan mode between "UNDER" and "NORMAL". (Disabled when using PC signal)	Level operation(Connected: UNDER, Open: NORMAL)
<b>R-TALLY<sup>*1</sup></b>	Lights the red tally.	Level operation (Connected: ON, Open: OFF)
<b>G-TALLY<sup>*1</sup></b>	Lights the green tally.	Level operation (Connected: ON, Open: OFF)
<b>MONO</b>	Switches between color and monochrome (MONO). (Disabled when using PC signal)	Level operation (Connected: Monochrome, Open: Color)
<b>GAMMA SELECT</b>	Used to select the gamma curve. (Disabled when using PC signal)	Level operation (Connected: FILM mode, Open: NORMAL mode)
<b>RGB SYNC<sup>*2</sup></b>	Selects the SYNC when using RGB-VIDEO input.	Level operation (Connected: EXT, Open: G-ON)

\*1 When both "R-TALLY" and "G-TALLY" are ON at the same time, the tally color becomes orange.

\*2 This is only enabled when "RGB-VIDEO" is selected in "YP<sub>BPr</sub>/RGB" in the "INPUT SELECT" menu.

# REMOTE Specifications (continued)

## ■ Assignment of item priority levels

- When both “MARKER1” and “MARKER2” are ON at the same time, “MARKER1” has priority.
- When both “MARKER BACKHALF” and “MARKER BACKBLACK” are ON at the same time, “MARKER BACKBLACK” has priority.
- When more than 2 of “INPUT SEL. VIDEO”, “INPUT SEL. Y/C”, “INPUT SEL. SDI1”, “INPUT SEL. SDI2”, “INPUT SEL. YPbPr/RGB” are ON at the same time, the one that was switched ON last has priority.

## RS-232C terminal

Refer to the following diagram and lower right table for the RS-232C terminal pin arrangement and connections. Please contact the vendor for information about detailed systems which used the RS-232C.

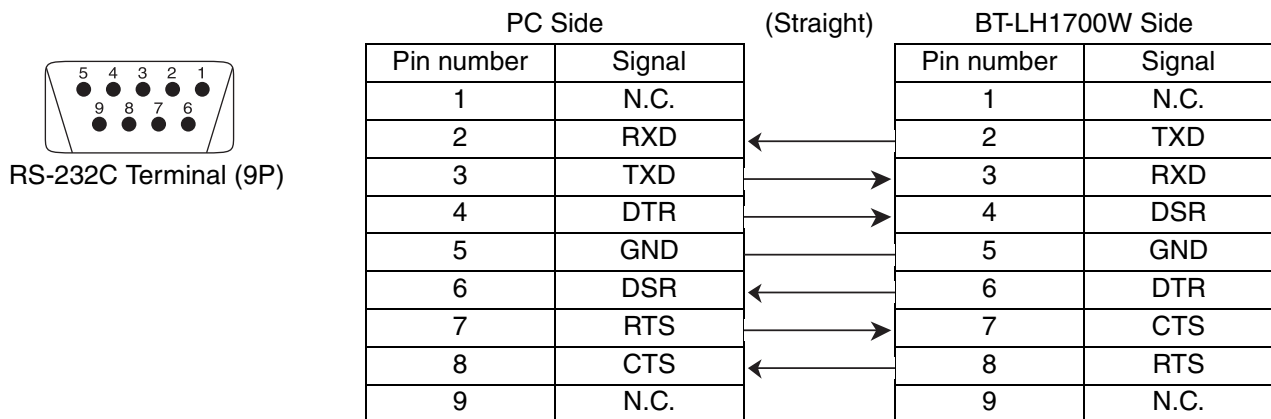

## RS-232C REMOTE operation method

### ■ Connectors and signal names

Connector: D-SUB 9-pin (female)

Signal name

Pin number	Signal name	Explanation
1	N.C.	Not connected
2	TXD	Transmission data
3	RXD	Reception data
4	DSR	Connected inside.
5	GND	Ground
6	DTR	Connected inside.
7	CTS	Connected inside.
8	RTS	Connected inside.
9	N.C.	Not connected

### ■ Communication Conditions

Signal level	Conforms to RS-232C
Synchro system	Tone pace synchro system
Transfer rate	9600 bps
Parity	None
Data length	8 bit
Stop bit	1 bit
Flow control	None

### ■ Command format

STX (02h)	Command	:	Data	ETX (03h)
-----------	---------	---	------	-----------

- Commands are 3 characters following STX, finally adding ETX.
- Add a : (colon) after the command as required, and add the data.

### ■ Response formats

1. Setting command response

STX (02h)	Command	ETX (03h)
-----------	---------	-----------

2. Query command response

STX (02h)	Data	ETX (03h)
-----------	------	-----------

3. Error response

STX (02h)	Error code	ETX (03h)
-----------	------------	-----------

Error code

ER001: Invalid command

ER002: Parameter error



## REMOTE Specifications (continued)

### ■ Setting command

No	Command	Explanation	Data	Response
1	IIS	Input switch	0: SDI1            1: SDI2            2: VIDEO 3: YP <sub>B</sub> P <sub>R</sub> /RGB    4: Y/C	IIS
2	VPS	Image quality adjustment	CON00-60 : Contrast settings BRI00-60 : Brightness settings CRO00-60 : Chroma settings PHA00-60 : Phase settings	VPS
3	OBO	Blue only	0: OFF                    1: ON	OBO
4	OHV	HV Delay	0: OFF            1: H DELAY        2: V DELAY 3: HV DELAY	OHV
5	DSD	Status display	0: CONTINUE    1: 3SEC OFF    2: OFF	DSD
6	IMS	Analog mode	ANA0: YP <sub>B</sub> P <sub>R</sub> ANA1: RGB-VIDEO ANA2: RGB-COMP.	IMS
7	IRF	RGB Sync	0: G-ON                    1: EXT	IRF
8	DMK	Marker settings	16:9 marker MK100: OFF                    MK101: 80% MK102: 88%                    MK103: 93% MK104: 95%                    MK105: 14:9 MK106: 13:9                    MK107: 4:3 MK108: 90%                    MK109: CNSCO MK110: VISTA 4:3 marker MK200: OFF                    MK201: 80% MK202: 88%                    MK203: 93% MK204: 95%                    MK208: 90% Marker background BAK0: NORMAL    BAK1: HALF    BAK2: BLACK Center marker CMK0: OFF                    CMK1: ON	DMK
9	MGM	Gamma selection	1: NORMAL                    2: FILM	MGM
10	MCT	Color temperature settings	00: D56            01: D65            02: D93 03: VAR1            04: VAR2            05: VAR3 10-73: USER0-63	MCT
11	VPC	Sharpness settings	SHP0: LOW                    SHP1: HIGH SHH00-30 Horizontal sharpness settings SHV00-30 Vertical sharpness settings	VPC
12	MIP	IP mode settings	0: MODE1                    1: MODE2	MIP
13	OMO	Monochrome settings	1: OFF                    2: ON	OMO
14	MAS	SD aspect settings	0: 16:9                    1: 4:3	MAS
15	MSC	Scan settings	0: NORMAL                    1: UNDER	MSC
16	MCO	Remote settings	0: LOCAL                    1: REMOTE	MCO
17	MLE	Remote operation settings	0: DISENABLE                    1: INPUT	MLE

# REMOTE Specifications (continued)

## ■ Query command

No	Command	Explanation	Data	Response
1	QIS	Input selection		0: SDI1      1: SDI2      2: YPbPr 3: RGB-VIDEO   4: VIDEO      5: Y/C 6: RGB-COMP.
2	QPC	Image quality adjustment	CON : Contrast setting value	00-60
			BRI : Brightness setting value	00-60
			CRO : Chroma setting value	00-60
			PHA : Phase setting value	00-60
3	QBO	Blue only		0: OFF      1: ON
4	QMK	Marker	MAK : Area marker	00: OFF      01: 80%      02: 88% 03: 93%      04: 95%      05: 14:9 06: 13:9      07: 4:3      08: 90% 09: CNSCO    10: VISTA
			BAK : Background	0: NORMAL    1: HALF      2: BLACK
			CMK : Center marker	0: OFF      1: ON
5	QGM	Gamma		1: NORMAL      2: FILM
6	QCT	Color temperature		00: D56      01: D65      02: D93 03: VAR1      04: VAR2      05: VAR3 10-73: USER0-63
7	QPC	Sharpness	SHP : Sharpness mode	0: LOW      1: HIGH
			SHH : Horizontal sharpness value	00-30
			SHV : Vertical sharpness value	00-30
8	QIP	IP mode		0: MODE1      1: MODE2
9	QMO	Monochrome		1: OFF      2: ON
10	QAS	Aspect		0: 16:9      1: 4:3
11	QSC	Scan		0: NORMAL      1: UNDER
12	QAN	Analog mode		0: YPbPr 2: RGB-VIDEO
13	QSY	RGB sync		0: G-ON      1: EXT
14	QFR	Format		01: 1080/60I      02: 1080/59I 03: 1080/50I      04: 1080/30P 05: 1080/29P      06: 1080/25P 07: 1080/24P      08: 1080/23P 09: 1080/24PsF    10: 1080/23PsF 13: 720/60P      14: 720/59P 15: 576/50I      16: 480/60P 17: 480/60I      18: 576/50P 20: 1080/60P      21: 1080/59P 22: 1080/50P      23: 720/50P 50: 640 x 400 (70Hz) 51: 640 x 480 (60Hz) 52: 640 x 480 (75Hz) 53: 640 x 480 (85Hz) 54: 800 x 600 (60Hz) 55: 800 x 600 (75Hz) 56: 800 x 600 (85Hz) 57: 1024 x 768 (60Hz) 58: 1024 x 768 (70Hz) 59: 1024 x 768 (75Hz) 60: 1024 x 768 (85Hz) 61: 1280 x 768 (60Hz) 62: 1280 x 768 (75Hz) 63: 1280 x 1024 (60Hz)

# How to Attach the Rack mounting

If you use rack-mounting adaptors BT-MA1710G (optional) with this monitor, you can incorporate a 19-inch standard rack (the height is 7U size). Please see the instructions below for attachment.

1. Remove the screws on the back and base of the monitor (3 places), and remove the stand.

2. Using the screws provided, attach the rack-mounting adaptors to both sides of the monitor.

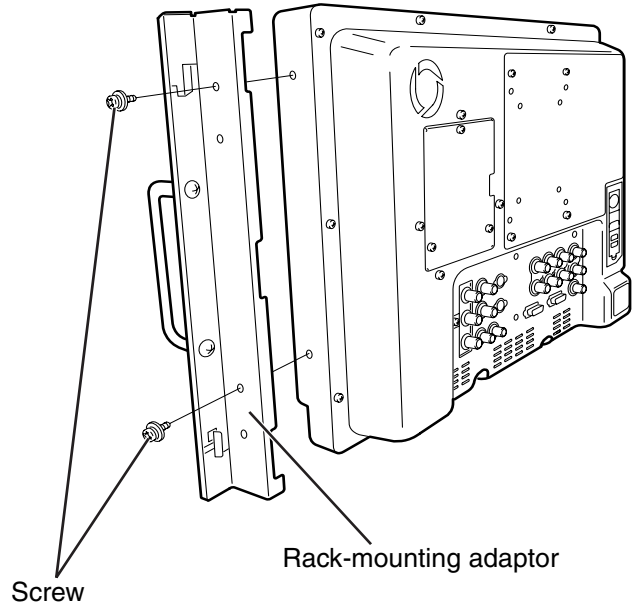
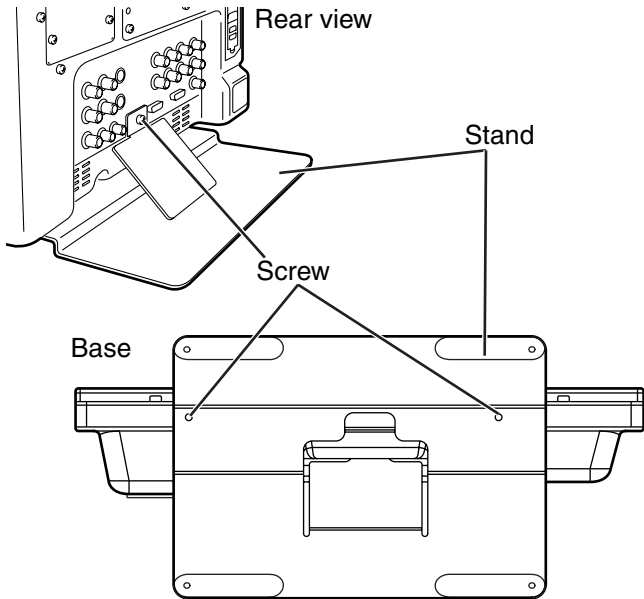

## Error/Warning Displays

If for any reason an error occurs in this monitor, the LEDs above the picture adjusting knob **flash at 1-second intervals** (informing you of the error/warning display).

Error/Warning displays	Symptom	Solution
<b>Inverter error</b>	If a malfunction occurs in the inverter that controls the backlight brightness, the backlight will switch OFF. The screen becomes completely black.	Switch the power supply OFF once, then switch it back ON again. If an error is still displayed, contact the vendor where you purchased the monitor.
<b>Fan stop Error</b>	The fan in the back of the monitor stops if a malfunction occurs. If a picture is being displayed when the malfunction occurs, it will continue being displayed as is.	If the error is still displayed after this, contact the vendor where you purchased the monitor immediately. If a fan stop error occurs, setting "FAN MOTOR" to "OFF" in the "SYSTEM CONFIG" menu (refer to page 18) allows you to continue using the monitor with reduced screen brightness.

## Maintenance

- To clean the cabinet or surface of the liquid crystal protection panel, gently wipe with a soft, dry cloth. If the surfaces are extremely dirty, use a soft cloth dipped in a weak detergent solution and then wrung-out to clean the surfaces, then use a dry cloth to finish. Water or similar substances getting inside the monitor can cause a malfunction.
- Never use thinner or benzene to clean this unit. Doing so would cause the surface of the monitor to become discolored, and cause paint to peel.
- Do not spray cleansers directly onto the monitor. Water or similar substances getting inside the monitor can cause a malfunction.

# Maintenance Inspections

Maintenance inspections are necessary for the user to use this equipment safely. It is important to keep monitor functions in good condition at all times through periodical and appropriate maintenance. In order to use this monitor for a long time, and to make full use of all of its functions, be sure to carry out the following maintenance inspections.

## 1. Necessity of periodical maintenance services

A backlight is used in the liquid crystal panel. This part (consumable) deteriorates as time passes, and can cause performance levels to drop, or may cause a malfunction.

Therefore, in addition to the after-service repairs performed if a malfunction occurs, it is essential that general servicing and maintenance servicing are conducted on a regular basis, to prevent malfunctions and accidents caused by the deterioration of consumable parts, and to keep the monitor working normally.

## 2. Standard maintenance time guidelines and items to be performed

The following maintenance performance times give standard guidelines for when to perform maintenance, and do not indicate the individual lifespan of your equipment. Also, note that the deterioration time varies depending on the usage environment and way in which the equipment is used.

Part name	Quantity	Periodic maintenance inspection time
Backlight and liquid crystal panel	1	Replace every 50,000 hours*
Fan	1	Replace every 10,000 hours

\* You cannot replace just the backlight unit on its own.

# Specifications

## ■ General

### Input power

	Power supply:	Power consumption:
AC:	100 V – 240 V, 50/60 Hz	1.1 A – 0.6 A
DC:	12 V (11 V – 17 V)	4.5 A

 is the safety information.

### Dimensions:

- Including stand  
430 (W) mm x 323.5 (H) mm x 198 (D) mm  
[16.9 (W) inches x 12.7 (H) inches x 7.8 (D) inches]
- Main body only, not including stand  
430 (W) mm x 309 (H) mm x 81.1 (D) mm  
[16.9 (W) inches x 12.2 (H) inches x 3.2 (D) inches]

### Weight:

- Including stand  
8.1 kg (17.9 lb)
- Main body only, not including stand  
7.2 kg (15.9 lb)

### Operating temperature:

+5 °C to +35 °C (+41 °F to +95 °F)

### Operating humidity:

20 % to 80 % (no condensation)

### Storage temperature:

-20 °C to +60 °C (-4 °F to +140 °F)

## ■ Panel

Size: 17.1 type  
Aspect ratio: 15:9  
Number of pixels: 1280 x 768 (WXGA)  
Display colors: Approx. 16,700,000 colors  
View angle: 176° up/down, 176° right/left

## ■ Input Connectors

### Image signal input:

#### VIDEO:

1 line, BNC x 2  
(1 connector with through-out configuration)

#### Y/C:

1 line, Y/C connector x 2  
(1 connector with through-out configuration)

#### Analog component:

1 line for YP<sub>B</sub>Pr/RG<sub>B</sub>S, BNC x 8  
(4 connectors with through-out configuration)  
However, when input is RGB-COMP. this becomes BNC x 5 (R, G, B, HD, and VD).  
(Through-out is not available)

#### SDI:

2 line, BNC x 3  
(1 connector with switched-out configuration)

Audio input: Pin jack x 2 (stereo)

GPI: D-SUB, 9 pins x 1

RS-232C: D-SUB, 9 pins x 1

DC input: XLR, 4 pins x 1

## ■ Signal level

### VIDEO

EXT SYNC signal level: 0.3 Vp-p to 4.0 Vp-p

HD/VD signal level: TTL level

### AUDIO

AUDIO input level: 0.5 Vrms

Speaker output: 0.5 W + 0.5 W

# Specifications (continued)

## ■ List of compatible signal formats

Input signal formats	VIDEO	Y/C	SDI1	SDI2	YPbPr	RGB-VIDEO	RGB-COMP.
NTSC	○	○					
PAL	○	○					
480/59.94I			○	○	○	○	
480/59.94P					○	○	
576/50I			○	○	○	○	
576/50P					○	○	
720/50P			○	○	○		
720/59.94P			○	○	○	○	
720/60P			○	○	○	○	
1035/59.94I			△ <sup>*1</sup>	△ <sup>*1</sup>	△ <sup>*1</sup>	△ <sup>*1</sup>	
1035/60I			△ <sup>*2</sup>	△ <sup>*2</sup>	△ <sup>*2</sup>	△ <sup>*2</sup>	
1080/23.98PsF			○	○	○		
1080/24PsF			○	○	○		
1080/23.98P			○	○	○		
1080/24P			○	○	○		
1080/25P			○	○	○		
1080/29.97P			○	○	○		
1080/30P			○	○	○		
1080/50I			○	○	○	○	
1080/50P					○		
1080/59.94I			○	○	○	○	
1080/60I			○	○	○	○	
1080/59.94P					○		
1080/60P					○		
640 x 400 (70Hz)							○
640 x 480 (60Hz)							○
640 x 480 (75Hz)							○
640 x 480 (85Hz)							○
800 x 600 (60Hz)							○
800 x 600 (75Hz)							○
800 x 600 (85Hz)							○
1024 x 768 (60Hz)							○
1024 x 768 (70Hz)							○
1024 x 768 (75Hz)							○
1024 x 768 (85Hz)							○
1280 x 768 (60Hz)							○
1280 x 768 (75Hz)							○
1280 x 1024 (60Hz)							○

\*1 When 1035/59.94I signal is input, displayed as 1080/59.94I. Other various marker displays will use the 1080/59.94I marker.

\*2 When 1035/60I signal is input, displayed as 1080/60I. Other various marker displays will use the 1080/60I marker.

Weight and dimensions when shown are approximately.  
Specifications are subject to change without notice.

# Panasonic®

**PANASONIC BROADCAST & TELEVISION SYSTEMS COMPANY**  
UNIT COMPANY OF PANASONIC CORPORATION OF NORTH AMERICA

**Executive Office:**

One Panasonic Way 4E-7, Secaucus, NJ 07094 (201) 348-7000

**EASTERN ZONE:**

One Panasonic Way 4E-7, Secaucus, NJ 07094 (201) 348-7621

**Southeast Region:**

1225 Northbrook Parkway, Ste 1-160, Suwanee, GA 30024 (770) 338-6835

**Central Region:**

1707 N Randall Road E1-C-1, Elgin, IL 60123 (847) 468-5200

**WESTERN ZONE:**

3330 Cahuenga Blvd W., Los Angeles, CA 90068 (323) 436-3500

**Government Marketing Department:**

52 West Gude Drive, Rockville, MD 20850 (301) 738-3840

**Broadcast PARTS INFORMATION & ORDERING:**

9:00 a.m. – 5:00 p.m. (EST) (800) 334-4881/24 Hr. Fax (800) 334-4880

Emergency after hour parts orders (800) 334-4881

**TECHNICAL SUPPORT:**

Emergency 24 Hour Service (800) 222-0741

**Panasonic Canada Inc.**

5770 Ambler Drive, Mississauga, Ontario L4W 2T3 (905) 624-5010

**Panasonic de Mexico S.A. de C.V.**

Av angel Urraza Num. 1209 Col. de Valle 03100 Mexico, D.F. (52) 1 951 2127

**Panasonic Puerto Rico Inc.**

San Gabriel Industrial Park, 65th Infantry Ave., Km. 9.5, Carolina, Puerto Rico 00630 (787) 750-4300